

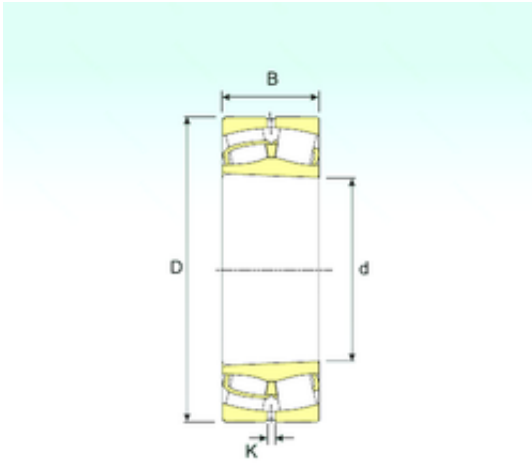

# INA BRAINGS SALES JAPAN CO.,LTD.



23030 K Bearing 2D drawings and 3D CAD models

150 mm x 225 mm x 56 mm ISB 23030 K  
spherical roller bearings

Bearing No. 23030 K

Size	150x225x56 mm
Bore Diameter	150 mm
Outer Diameter	225 mm
Width	56 mm
d	150 mm
D	225 mm
B	56 mm
C	56 mm
K	4,5 mm
Weight	7,95 Kg
Basic dynamic load rating (C)	500 kN
Basic static load rating (C0)	735 kN
(Grease) Lubrication Speed	2448 r/min